

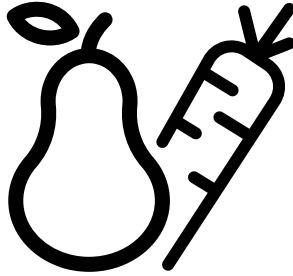

Refrigerator User Manual



274580 EB-274580 EI-274580EDI-2476 CEI
274581EB-274581EI-274532EI



Please read this user manual first!

Dear Customer,

We hope that your product, which has been produced in modern plants and checked under the most meticulous quality control procedures, will provide you an effective service.

Therefore, read this entire user manual carefully before using the product and keep it as a reference. If you handover the product to someone else, give the user manual as well.

The user manual will help you use the product in a fast and safe way.

- Read the manual before installing and operating the product.
- Make sure you read the safety instructions.
- Keep the manual in an easily accessible place as you may need it later.
- Read the other documents given with the product.

Remember that this user manual is also applicable for several other models. Differences between models will be identified in the manual.

Explanation of symbols

Throughout this user manual the following symbols are used:







Important information or useful tips.



Warning against dangerous conditions for life and property.



Warning against electric voltage.

 INFORMATION	
 ENERGY 	.The model information as stored in the product data base can be reached by entering following website and searching for your model identifier (*) found on energy label.
SUPPLIER'S NAME  MODEL IDENTIFIER  (*)	https://eprel.ec.europa.eu/

CONTENTS

1 Your Refrigerator	3	4 Preparation	13
2 Important Safety Warnings	4	5 Using your refrigerator Indicator Panel	14
Intended use	4	Indicator Panel.....	14
For products with a water dispenser;	6	Indicator Panel.....	16
Child safety.....	6	Indicator Panel.....	19
Compliance with WEEE Directive and Disposing of the Waste Product:	6	Indicator Panel.....	22
Compliance with RoHS Directive:	7	Door Open Warning.....	25
Package information.....	7	Dual cooling system:	25
HCA Warning	7	Freezing fresh food	25
Things to be done for energy saving ..	7	Recommendations for preservation of frozen food	26
Technical information for Wifi + Bluetooth.....	8	Defrosting.....	26
Recommendations for the fresh food compartment.....	9	Placing the food	26
3 Installation	10	Deep-freeze information	27
Points to be paid attention to when the relocation of the refrigerator	10	Odour filter	28
Electrical connection.....	10	Egg section	28
Disposing of the packaging	11	Blue light/VitaminZone.....	28
Disposing of your old refrigerator	11	Water Dispenser	29
Placing and Installation	11	Sliding storage container	31
Adjusting the legs	12	Rotary storage container	31
Changing the illumination lamp	12	Ice making.....	32
		Movable Body shelf:	32
		Humidity Controlled Crisper	33
		(FreSHelf).....	33
		HerbBox/HerbFresh	33
		6 Maintenance and cleaning	34
		Protection of plastic surfaces	34
		7 Troubleshooting	35

1 Your Refrigerator

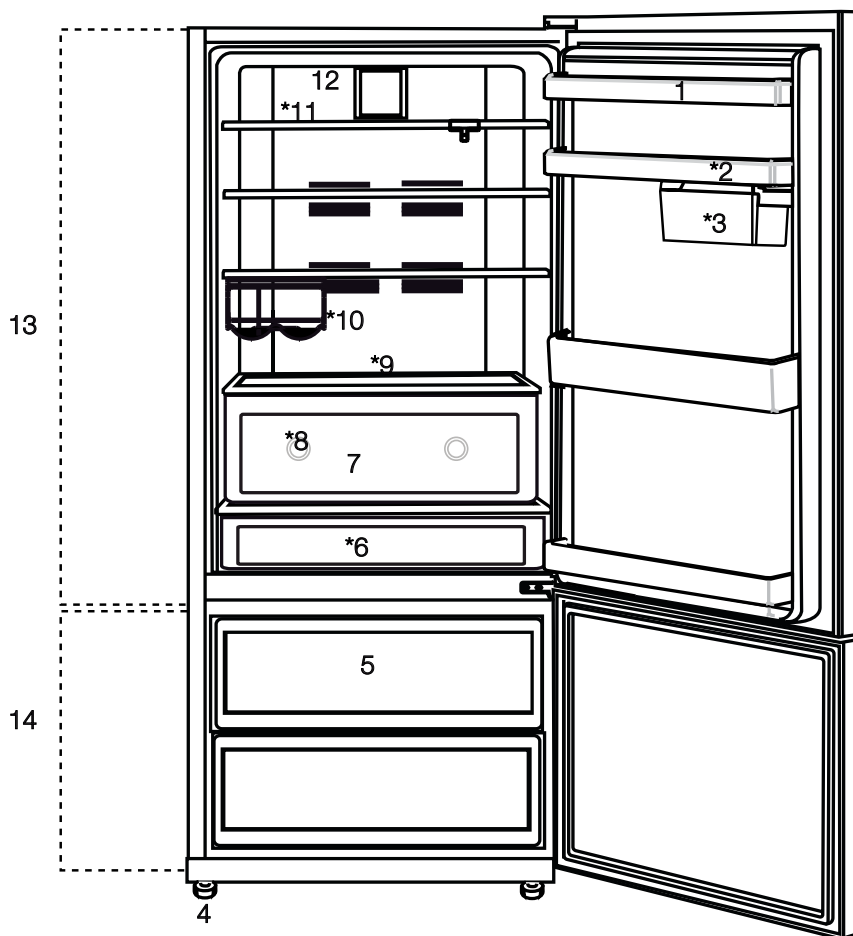

- | | | | |
|----|--|-----|---------------------------|
| 1. | Egg holder | 8. | *Blue light |
| 2. | *Door shelves | 9. | *Adjustable glass shelves |
| 3. | *Sliding and Rotary storage containers | 10. | *Bottle shelf |
| 4. | Adjustable legs | 11. | *Movable body shelf |
| 5. | Freezer compartment drawers | 12. | Fan |
| 6. | *Snack compartment/Crisper | 13. | Fridge compartment |
| 7. | Crisper | 14. | Freezer compartment |

***optional**

ⓘ Figures that take place in this instruction manual are schematic and may not correspond exactly with your product. If the subject parts are not included in the product you have purchased, then it is valid for other models.

2 Important Safety Warnings

Please review the following information. Failure to observe this information may cause injuries or material damage. Otherwise, all warranty and reliability commitments will become invalid. Original spare parts will be provided for 10 years, following the product purchasing date.

Intended use

- WARNING: Keep ventilation openings, in the appliance enclosure or in the built-in structure, clear of obstruction.
- WARNING: Do not use mechanical devices or other means to accelerate the defrosting process, other than those recommended by the manufacturer.
- WARNING: Do not damage the refrigerant circuit.

This warning is only applicable to appliances with refrigerating circuits which are accessible to the user.

- WARNING: Do not use electrical appliances inside the food storage compartments of the appliance, unless they are of the type recommended by the manufacturer.

This appliance is intended to be used in household and similar applications such as

- staff kitchen areas in shops, offices and other working environments;
- farm houses and by clients in hotels, motels and other residential type environments;
- bed and breakfast type environments;
- catering and similar non-retail applications.

General safety

- When you want to dispose/ scrap the product, we recommend you to consult the authorized service in order to learn the required information and authorized bodies.
- Consult your authorized service for all your questions and problems related to the refrigerator. Do not intervene or let someone intervene to the refrigerator without notifying the authorised services.
- For products with a freezer compartment; Do not eat cone ice cream and ice cubes immediately after you take them out of the freezer compartment! (This may cause frostbite in your mouth.)
- For products with a freezer compartment; Do not put bottled and canned liquid beverages in the freezer compartment. Otherwise, these may burst.
- Do not touch frozen food by hand; they may stick to your hand.
- Unplug your refrigerator before cleaning or defrosting.
- Vapor and vaporized cleaning materials should never be used in cleaning and defrosting processes of your refrigerator. In such cases, the vapor may get in contact with the electrical parts and cause short circuit or electric shock.
- Never use the parts on your refrigerator such as the door as a means of support or step.
- Do not use electrical devices inside the refrigerator.
- Do not damage the parts, where the refrigerant is circulating, with drilling or cutting tools. The refrigerant

that might blow out when the gas channels of the evaporator, pipe extensions or surface coatings are punctured causes skin irritations and eye injuries.

- Do not cover or block the ventilation holes on your refrigerator with any material.
- Electrical devices must be repaired by only authorised persons. Repairs performed by incompetent persons create a risk for the user.
- In case of any failure or during a maintenance or repair work, disconnect your refrigerator's mains supply by either turning off the relevant fuse or unplugging your appliance.
- Do not pull by the cable when pulling off the plug.
- Ensure highly alcoholic beverages are stored securely with the lid fastened and placed upright.
- Never store spray cans containing flammable and explosive substances in the refrigerator.
- Do not use mechanical devices or other means to accelerate the defrosting process, other than those recommended by the manufacturer.
- This product is not intended to be used by persons with physical, sensory or mental disorders or unlearned or inexperienced people (including children) unless they are attended by a person who will be responsible for their safety or who will instruct them accordingly for use of the product
- Do not operate a damaged refrigerator. Consult with the service agent if you have any concerns.
- Electrical safety of your refrigerator shall be guaranteed only

if the earth system in your house complies with standards.

- Exposing the product to rain, snow, sun and wind is dangerous with respect to electrical safety.
- Contact authorized service when there is a power cable damage to avoid danger.
- Never plug the refrigerator into the wall outlet during installation. Otherwise, risk of death or serious injury may arise.
- This refrigerator is intended for only storing food items. It must not be used for any other purpose.
- Label of technical specifications is located on the left wall inside the refrigerator.
- Never connect your refrigerator to electricity-saving systems; they may damage the refrigerator.
- If there is a blue light on the refrigerator, do not look at the blue light with optical tools.
- For manually controlled refrigerators, wait for at least 5 minutes to start the refrigerator after power failure.
- This operation manual should be handed in to the new owner of the product when it is given to others.
- Avoid causing damage on power cable when transporting the refrigerator. Bending cable may cause fire. Never place heavy objects on power cable. Do not touch the plug with wet hands when plugging the product.

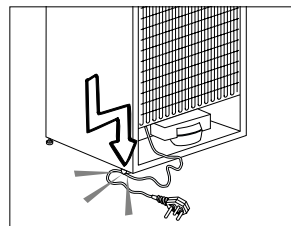

- Do not plug the refrigerator if the wall outlet is loose.
- Water should not be sprayed directly on inner or outer parts of the product for safety purposes.
- Do not spray substances containing inflammable gases such as propane gas near the refrigerator to avoid fire and explosion risk.
- Never place containers filled with water on top of the refrigerator, otherwise this may cause electric shock or fire.
- Do not overload your refrigerator with excessive amounts of food. If overloaded, the food items may fall down and hurt you and damage refrigerator when you open the door. Never place objects on top of the refrigerator; otherwise, these objects may fall down when you open or close the refrigerator's door.
- As they require a precise temperature, vaccines, heat-sensitive medicine and scientific materials and etc. should not be kept in the refrigerator.
- If not to be used for a long time, refrigerator should be unplugged. A possible problem in power cable may cause fire.
- Refrigerator may move if adjustable legs are not properly secured on the floor. Properly securing adjustable legs on the floor can prevent the refrigerator to move.
- When carrying the refrigerator, do not hold it from door handle. Otherwise, it may be snapped.
- When you have to place your product next to another refrigerator or freezer, the distance between devices should be at least 8cm. Otherwise, adjacent side walls may be humidified.

For products with a water dispenser;

Pressure of water mains should be minimum 1 bar. Pressure of water mains should be maximum 8 bars.

- Use only potable water.

Child safety

- If the door has a lock, the key should be kept away from reach of children.
- Children must be supervised to prevent them from tampering with the product.

Compliance with WEEE Directive and Disposing of the Waste Product:

This product complies with EU WEEE Directive (2012/19/EU). This product bears a classification symbol for waste electrical and electronic equipment (WEEE). This product has been manufactured with high quality parts and materials which can be reused and are suitable for recycling. Do not dispose of the waste product with normal domestic and other wastes at the end of its service life. Take it to the collection center for the recycling of electrical and electronic equipment. Please consult your local authorities to learn about these collection centers.



Compliance with RoHS Directive:

The product you have purchased complies with EU RoHS Directive [2011/65/EU]. It does not contain harmful and prohibited materials specified in the Directive.

Package information

Packaging materials of the product are manufactured from recyclable materials in accordance with our National Environment Regulations. Do not dispose of the packaging materials together with the domestic or other wastes. Take them to the packaging material collection points designated by the local authorities.

HCA Warning

If your product's cooling system contains R600a:

This gas is flammable. Therefore, pay attention to not damaging the cooling system and piping during usage and transportation. In the event of damage, keep your product away from potential fire sources that can cause the product catch a fire and ventilate the room in which the unit is placed.

Ignore this warning if your product's cooling system contains R134a.

Type of gas used in the product is stated in the type plate which is on the left wall inside the refrigerator.

Never throw the product in fire for disposal.

Things to be done for energy saving

- Pay attention not to open doors very frequently and do not leave the doors open for a long time. When doors are open, warm air enters the fridge/freezer cabinets and the appliance consumes

more energy to cool down the foodstuffs. Thus please do not open doors frequently in order to save energy and to keep foods at ideal storage temperature.

- Do not block the freezer fan grill by placing foods in front.
- Do not put hot food or drinks in your refrigerator.
- Do not overload your refrigerator so that the air circulation inside is not prevented.
- Do not install your refrigerator under direct sunlight or near heat emitting appliances such as ovens, dishwashers or radiators.
- Pay attention to keep your food in closed containers.
- Thawing frozen food in fridge compartment will both provide energy saving and preserve the food quality.

- Please use provided 2 pieces of cold packs (pcm) at recommended places below when storing foodstuffs in freezer compartments.

It helps to keep your foodstuffs colder for more time when electricity is off or your appliance is unplugged.

- If you do not plan to store foodstuff in freshfood compartment, please activate vacation mode for energy saving. Freezer compartment keeps freezing normally

when vacation mode is on.

- Recommended temperature settings are +4°C and -18°C for freshfood and freezer compartments respectively.

- To be able store maximum food in the freezer compartment of your

Technical information for Wifi + Bluetooth

Frequency Band:

Frequency Band:	2.4GHz (Wi-fi or bluetooth operational)
Max. Transmission Power:	< 100mW (Wi-fi or bluetooth operational)
Software information:	Quartz_WiFi.XXX

Conformity Declaration for CE:

Arçelik A.Ş. hereby declares that this appliance complies with Directive 2014/53/EU.

The complete text of the EU declaration of conformity is available in the following internet address:

Products, From: arcelik.com.tr

refrigerator, the upper drawer has to be removed and placed on top of wire rack. Power consumption stated for your refrigerator has been determined after removing the icebox, ice tray and upper drawer as to allow maximum loading. Using the lower drawer while loading is highly recommended.

- Airflow should not be blocked by placing foods in front of the freezer compartment fan. Foods should be loaded by leaving minimum 5 cm space in front of the protective fan grid.

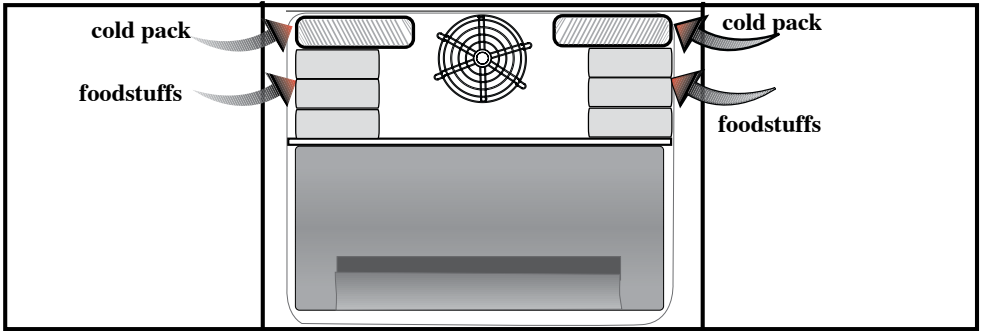

Recommendations for the fresh food compartment

***May not be available in all models**

Do not allow the food to touch the temperature sensor in fresh food compartment. To allow the fresh food compartment keep its ideal storage temperature, sensor must not be hindered by food.

Do not place hot foods in the product.

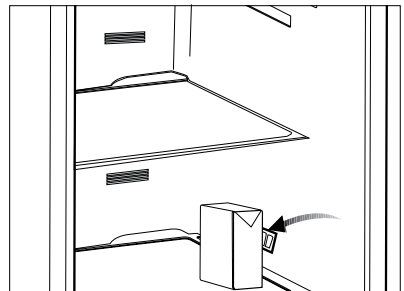

3 Installation



In case the information which are given in the user manual are not taken into account, manufacturer will not assume any liability for this.

Points to be paid attention to when the relocation of the refrigerator

1. Your refrigerator should be unplugged. Before transportation of your refrigerator, it should be emptied and cleaned.

2. Before it is re-packaged, shelves, accessories, crisper, etc. inside your refrigerator should be fixed with adhesive tape and secured against impacts. Package should be bound with a thick tape or sound ropes and the transportation rules on the package should be strictly observed.

3. Original packaging and foam materials should be kept for future transportations or moving. Before you start the refrigerator,

Check the following before you start to use your refrigerator:

1. Attach 2 plastic wedges as illustrated below. Plastic wedges are intended to keep the distance which will ensure the air circulation between your refrigerator and the wall. (The picture is drawn up as a representation and it is not identical with your product.)

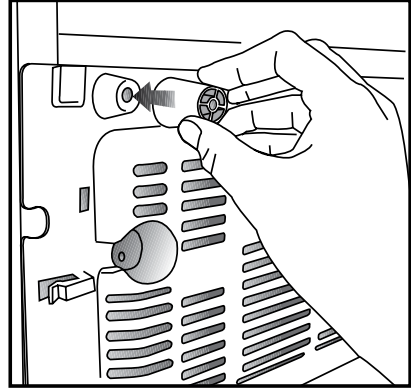

2. Clean the interior of the refrigerator as recommended in the “Maintenance and cleaning” section.

3. Connect the plug of the refrigerator to the wall socket. When the fridge door is opened, fridge internal lamp will turn on.

4. When the compressor starts to operate, a sound will be heard. The liquid and gases sealed within the refrigeration system may also give rise to noise, even if the compressor is not running and this is quite normal.

5. Front edges of the refrigerator may feel warm. This is normal. These areas are designed to be warm to avoid condensation.

Electrical connection

Connect your product to a grounded socket which is being protected by a fuse with the appropriate capacity.

Important:

The connection must be in compliance with national regulations.

- The power plug must be easily accessible after installation.

- Electrical safety of your refrigerator shall be guaranteed only if the earth system in your house complies with standards.
- The voltage stated on the label located at left inner side of your product should be equal to your network voltage.
- Extension cables and multi plugs must not be used for connection.



A damaged power cable must be replaced by a qualified electrician.



Product must not be operated before it is repaired! There is the risk of electric shock!

Disposing of the packaging

The packing materials may be dangerous for children. Keep the packing materials out of the reach of children or dispose of them by classifying them in accordance with the waste instructions stated by your local authorities. Do not throw away with regular house waste, throw away on packaging pick up spots designated by the local authorities.

The packing of your refrigerator is produced from recyclable materials.

Disposing of your old refrigerator

Dispose of your old refrigerator without giving any harm to the environment.

- You may consult your authorized dealer or waste collection center of your municipality about the disposal of your refrigerator.

Before disposing of your refrigerator, cut out the electric plug and, if there are any locks on the door, make them inoperable in order to protect children against any danger.

Placing and Installation



If the entrance door of the room where the refrigerator will be installed is not wide enough for the refrigerator to pass through, then call the authorized service to have them remove the doors of your refrigerator and pass it sideways through the door.

1. Install your refrigerator to a place that allows ease of use.
2. Keep your refrigerator away from heat sources, humid places and direct sunlight.
3. Your product requires adequate air circulation to function efficiently. If the product will be placed in an alcove, remember to leave at least 5 cm clearance between the product and the ceiling, rear wall and the side walls.
4. If the product will be placed in an alcove, remember to leave at least 5 cm clearance between the product and the ceiling, rear wall and the side walls. Check if the rear wall clearance protection component is present at its location (if provided with the product). If the component is not available, or if it is lost or fallen, position the product so that at least 5 cm clearance shall be left between the rear surface of the product and the wall of the room. The clearance at the rear is important for efficient operation of the product.
5. Place your refrigerator on an even floor surface to prevent jolts.

Adjusting the legs

If your refrigerator is unbalanced; You can balance your refrigerator by turning its front legs as illustrated in the figure. The corner where the leg exists is lowered when you turn in the direction of black arrow and raised when you turn in the opposite direction. Taking help from someone to slightly lift the refrigerator will facilitate this process.

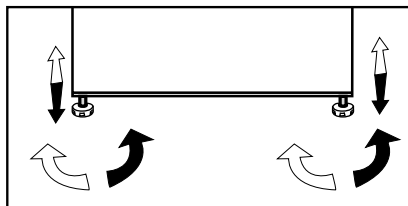

Changing the illumination lamp

To change the Bulb/LED used for illumination of your refrigerator, call your AuthorisedService.

The lamp(s) used in this appliance is not suitable for household room illumination. The intended purpose of this lamp is to assist the user to place foodstuffs in the refrigerator/freezer in a safe and comfortable way. The lamps used in this appliance have to withstand extreme physical conditions such as temperatures below -20°C .

(only chest and upright freezer)

4 Preparation

- for a freestanding appliance; 'this refrigerating appliance is not intended to be used as a built-in appliance' ;
- Your refrigerator should be installed at least 30 cm away from heat sources such as hobs, ovens, central heater and stoves and at least 5 cm away from electrical ovens and should not be located under direct sunlight.
- The ambient temperature of the room where you install your refrigerator should at least be 10°C. Operating your refrigerator under cooler conditions is not recommended with regard to its efficiency.
- Please make sure that the interior of your refrigerator is cleaned thoroughly.
- If two refrigerators are to be installed side by side, there should be at least 2 cm distance between them.
- When you operate your refrigerator for the first time, please observe the following instructions during the initial six hours.
- The door should not be opened frequently.
- It must be operated empty without any food in it.
- Do not unplug your refrigerator. If a power failure occurs out of your control, please see the warnings in the "Recommended solutions for the problems" section.
- Original packaging and foam materials should be kept for future transportations or moving.
- The baskets/drawers that are provided with the chill compartment must always be in use for low energy consumption and for better storage conditions.
- Food contact with the temperature sensor in the freezer compartment may increase energy consumption of the appliance. Thus any contact with the sensor(s) must be avoided.
- In some models, the instrument panel automatically turns off 5 minutes after the door has closed. It will be reactivated when the door has opened or pressed on any key.
- Due to temperature change as a result of opening/closing the product door during operation, condensation on the door/body shelves and the glass containers is normal
- Since hot and humid air will not directly penetrate into your product when the doors are not opened, your product will optimize itself in conditions sufficient to protect your food. In this energy saving function, functions and components such as compressor, fan, heater, defrost, lighting, display and so on will operate according to the needs to consume minimum energy while maintaining the freshness of your foodstuff.

5 Using your refrigerator Indicator Panel

Indicator Panel

Indicator panels may vary depending on your product's model.

Indicator panel aids in using your refrigerator with its audio and visual functions.

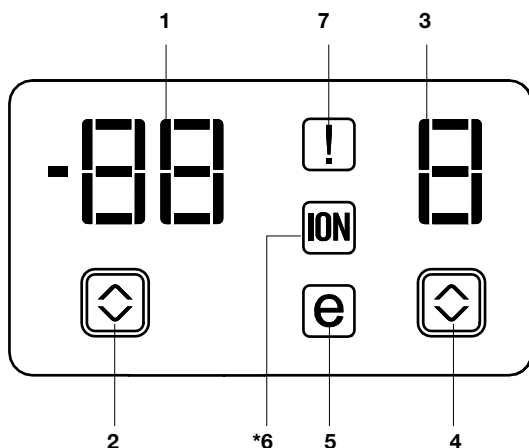

1. Freezer Compartment Temperature Indicator
2. Error Status Indicator
3. Fridge Compartment Temperature Indicator
4. Fridge Compartment Temperature Setting Button
5. Economy Mode Indicator
6. Ioniser Indicator
7. Freezer Compartment Temperature Setting Button

i Figures that take place in this instruction manual are schematic and may not correspond exactly with your product. If the subject parts are not included in the product you have purchased, then it is valid for other models.

1. Freezer Compartment Temperature Indicator

It indicates the temperature set for Freezer compartment.

2. Error Status Indicator

If your refrigerator does not cool adequately or if there is a sensor failure, this indicator will be activated. When this indicator is active, Freezer Compartment Temperature indicator will display "e" and Fridge Compartment Temperature Indicator will display numbers such as "1,2,3...". These numbers on the indicator provides information about the error to the service personnel.

3. Fridge Compartment Temperature Indicator

Indicates the temperature set for Fridge compartment.

4. Fridge Compartment Temperature Setting Button

Press this button to set the temperature of the fridge compartment to 8, 6, 4, 2, 8... respectively. Press this button to set the desired temperature for the fridge compartment.

5. Economy Mode Indicator

Indicates that the refrigerator is running in energy-efficient mode.

6. Ioniser Indicator

Indicator light lights up continuously. This light indicates that your refrigerator is protected against the bacteria.

7. Freezer Compartment Temperature Setting Button

Press this button to set the temperature of the freezer compartment to -15, -18, -21, -24, -15... respectively. Press this button to set the desired temperature for the freezer compartment.

Indicator Panel

Indicator panels may vary depending on your product's model.

Indicator panel aids in using your refrigerator with its audio and visual functions.

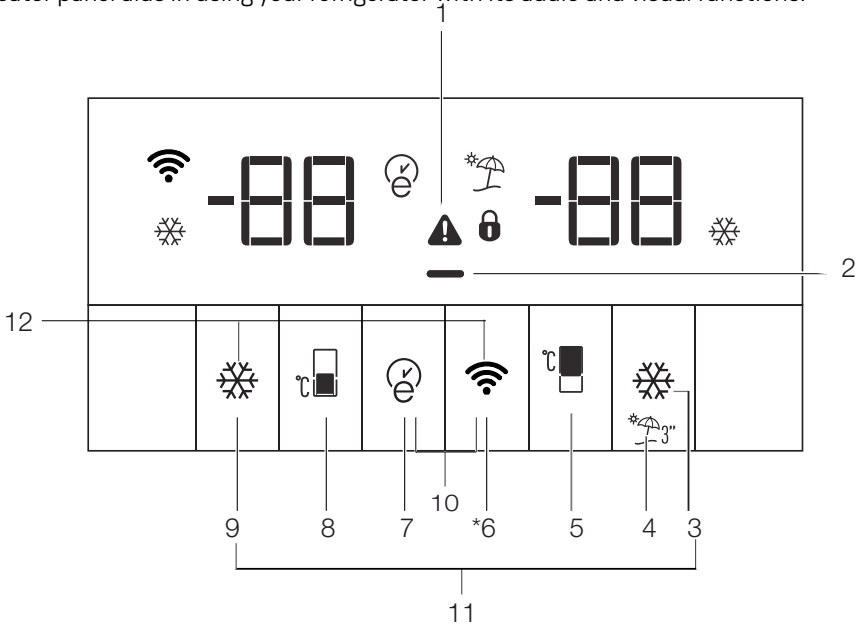

1. Error status indicator
2. Energy saving function [display off] indicator
3. Quick fridge key
4. Vacation function key
5. Fridge compartment temperature setting key
6. Wireless connection key
7. Eco-fuzzy key
8. Freezer compartment temperature setting key
9. Quick freeze button
10. Key lock[3 seconds]/Alarm off [short press]
11. Key for changing temperature unit
12. Wifi Configuration Reset Button

I Figures that take place in this instruction manual are schematic and may not correspond exactly with your product. If the subject parts are not included in the product you have purchased, then it is valid for other models.

1. Error status indicator

If your refrigerator does not cool adequately or if there is a sensor failure, this indicator () will be activated. When this indicator is active, Freezer Compartment Temperature indicator will display "E" and Fridge Compartment Temperature Indicator will display numbers such as "1,2,3...". These numbers on the indicator provide information about the error to the service personnel.

When you place hot food into the freezer compartment or if you leave the door open for a long time, exclamation mark can illuminate for some time. This is not a failure; this warning will disappear when the food cools down.

2. Energy saving function (display off) indicator



If the product doors are kept closed for a long time energy saving function is automatically activated and energy saving symbol is illuminated. ()

When energy saving function is activated, all symbols on the display other than energy saving symbol will turn off. When the energy saving function is activated, if any button is pressed or the door is opened, energy saving function will be canceled and the symbols on display will return to normal. Energy saving function is a factory default and cannot be cancelled.

3. Quick fridge key

Quick fridge indicator () is lit and the fridge compartment temperature indicator value is displayed as 1 when the quick fridge function is activated. To cancel this function, press the Quick fridge button again. Quick fridge indicator will be off and the refrigerator will be reset to its normal settings. Quick fridge function is cancelled automatically in 1 hour if you do not cancel it. If you want to cool large amounts of fresh food, press the Quick fridge button before putting the food into the fridge compartment.

4. Vacation function key

In order to activate vacation function, press and hold the button () for 3 seconds and the vacation mode indicator () will be activated. When the vacation function is activated, "--" is displayed on the fridge compartment temperature indicator and no active cooling is performed in the fridge compartment. It is not suitable to keep the food in the fridge compartment when this function is activated. Other compartments will continue to be cooled according to their set temperatures.

To cancel this function, press **vacation function** button again.

5. Fridge compartment temperature setting button

When this button is pressed the fridge compartment temperature can be set to 8,7,6,5,4,3,2 and 1 values. ()

6. Wireless connection (*optional) key

This button is used to make a wireless connection to your product via the HomeWhiz mobile application.

By long pressing the button (3 seconds), the wireless icon on the display / indicator flashes slowly (at 0.5 second intervals). The first introduction of the home network to the product is started in this way.

After the wireless connection is established with the product, the wireless connection icon () lights constantly. After completing the initial setup, the connection can be activated/deactivated by pressing this button. The wireless icon flashes fast (at 0.2 second intervals) until the connection is established. When the connection is active, the wireless network icon lights continuously.

If the connection cannot be established for a long time, check your connection settings and see the 'Troubleshooting' section in the user manual.

HomeWhiz application should be used for wireless connection. Installation steps are explained through the application during installation.

You can go to the application by reading the QR code on the HomeWhiz label on the product. The app is available in the App Store on iOS devices and the Play Store on Android devices.

For detailed information, visit <https://www.homewhiz.com/>.

7. Eco-fuzzy key

Press the eco-fuzzy button to enable the eco fuzzy function. When this function is enabled, the freezer will start to run in eco mode after at least 6 hours and the economical use indicator will be on. () To disable the eco-fuzzy function, press the eco-fuzzy function button again. When the eco-fuzzy function is enabled, this indicator will turn on after 6 hours.

8. Freezer button temperature setting key

Temperature setting is made for freezer compartment.





When the button numbered () is pressed, you can set the temperature of the freezer compartment to -18, -19, -20, -21, -22, -23 and -24.

9. Quick freeze button



Press button no. (9) for quick freeze; the quick freeze indicator () will be activated.

When the quick freeze function is on, the quick freeze indicator is lit and the freezer compartment temperature indicator displays -27. To cancel this function press the quick freeze button () again. The quick freeze indicator will turn off and the refrigerator will return to its normal settings. Quick freeze function is cancelled automatically in 25 hours if you do not cancel it. If you want to freeze large amounts of fresh food, press the quick freeze button before putting the food into the freezer compartment.



10. Key lock/Alarm off

Press and hold the wireless network () and eco-fuzzy () buttons simultaneously for 3 seconds. Key lock symbol () will light up and key lock mode will be activated. Buttons will not function when the key lock mode is active. Press and hold the wireless network () and eco-fuzzy () buttons simultaneously for 3 seconds. Key lock will be deactivated.



Use the **key lock** function if you want to prevent changing of the temperature setting of the refrigerator.

When there is a power outage/ electricity cut for a long time, the hottest temperature reached by the freezer compartment flashes on the digital display together with the exclamation () icon. After checking the freezer compartment foods, the alert can be cleared by simultaneously pressing the wireless network () and the eco fuzzy () button.

11. Key for changing temperature unit

Press and hold the Quick Fridge () And Quick Freeze () keys for 3 seconds to switch between Fahrenheit and Celsius.

12-Wifi Configuration Reset Button

To reset the wireless connection settings, Quick freeze () and Wireless connection () buttons should be pressed for 3 seconds.

The product whose wireless connection settings have been reset / returned to factory settings will forget all user information that was set up earlier.

Indicator Panel

Indicator panels may vary depending on your product's model.

Indicator panel aids in using your refrigerator with its audio and visual functions.

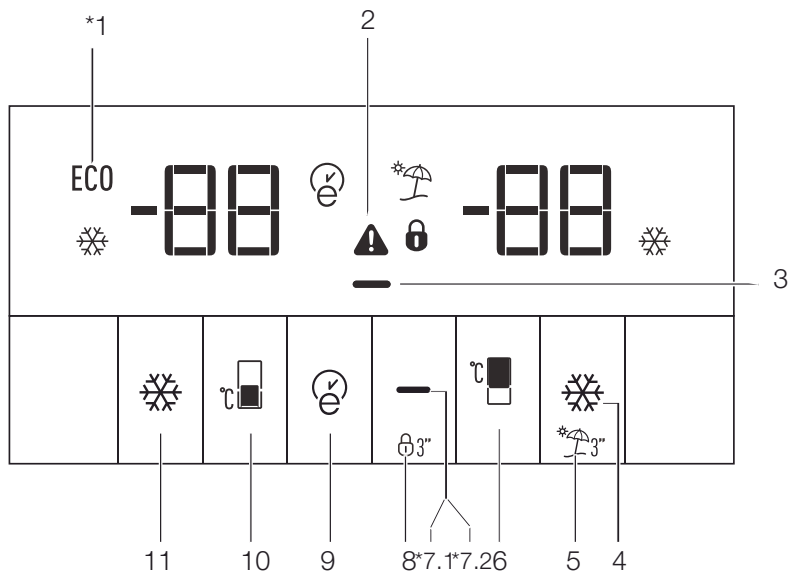

- | | |
|--|--|
| 1. Economy | 8. Key lock |
| 2. Power failure/High temperature / error warning indicator | 9. Eco fuzzy |
| 3. Energy saving function (display off) | 10. Freezer compartment temperature setting |
| 4. Quick cool | 11. Fast freeze |
| 5. Vacation function | |
| 6. Fridge compartment temperature setting | |
| 7. Energy saving function (display off)/Alarm off warning | |

ⓘ Figures that take place in this instruction manual are schematic and may not correspond exactly with your product. If the subject parts are not included in the product you have purchased, then it is valid for other models.

1. Economy

This symbol is illuminated when the freezer compartment is set to -18°C as the most economical setting value (ECO). Economy indicator is turned off when quick cooling or quick freeze functions are selected.

2. Power failure/High temperature / error warning indicator

This indicator (▲) illuminates during power failure, high temperature failures and error warnings. During sustained power failures, the highest temperature that the freezer compartment reaches will flash on the digital display. After checking the food located in the freezer compartment (—) press the alarm off button to clear the warning.

3. Energy saving function (display off)

If the product doors are kept closed for a long time energy saving function is automatically activated and energy saving symbol is illuminated. When energy saving function is activated, all symbols on the display other than energy saving symbol will turn off. When the Energy Saving function is activated, if any button is pressed or the door is opened, energy saving function will be canceled and the symbols on display will return to normal.

4. Quick cool

Quick cooling indicator (❄) is illuminated when quick cooling function is activated and fridge compartment temperature indicator value is displayed as 1. To cancel this function press Quick cooling button again. Quick cooling indicator will turn off and refrigerator will return to its normal settings. Quick cooling function is canceled automatically in 1 hour if you do not cancel it before. If you want to cool large amounts of fresh food, press the Quick cooling button before putting the food into the fridge compartment.

5. Vacation function

In order to activate vacation function, press the button no. (5) (🌳) for 3 seconds, and the vacation mode indicator activates. When the vacation function is activated, “- -” is displayed on the fridge compartment temperature indicator and no active cooling is performed on the fridge compartment. It is not suitable to keep the food in the fridge compartment when this function is activated. Other compartments shall be continued to be cooled as per their set temperature. To cancel this function press **Vacation** function button again.

6. Fridge compartment temperature setting

When the button no. (6) is pressed, you may set the temperature of the fridge compartment to 8,7,6,5,4,3,2 and 1 respectively (📊).

7.1. Energy saving function (display off):

Energy saving symbol (—) is illuminated and Energy saving function is activated when you press this button (—). When energy saving function is activated, all symbols on the display other than energy saving symbol will turn off. When the Energy Saving function is activated, if any button is pressed or the door is opened, energy saving function will be canceled and the symbols on display will return to normal. Energy saving symbol is turned off and energy saving function is deactivated when you press this button (—) again.

7.2. Alarm off warning:

In case of power failure/high temperature alarm, after checking the food located in the freezer compartment press the alarm off button to clear the warning.

8. Key lock

Press key lock button (🔒) simultaneously for 3 seconds. Key lock symbol (🔒) will light up and key lock mode will

be activated. Buttons will not function if the Key lock mode is active. Press key lock button simultaneously for 3 seconds again. Key lock symbol will turn off and the key lock mode will be exited.

Press the **key lock** button if you want to prevent changing of the temperature setting of the refrigerator (🔒).

9. Eco fuzzy

Press and hold eco fuzzy button for 1 seconds to activate eco fuzzy function. Refrigerator will start operating in the most economic mode at least 6 hours later and the economic usage indicator will turn on when the function is active (🌿). Press and hold eco fuzzy function button for 3 seconds to deactivate eco fuzzy function.

This indicator is illuminated after 6 hours when eco fuzzy is activated.

10. Freezer compartment temperature setting

Temperature setting for freezer compartment is performed here. When button no. 9 is pressed, you may set the temperature of the freezer compartment to -18, -19, -20, -21, -22, -23 and -24 respectively.

11. Fast freeze

Press button no. (11) for fast freeze operation, quick freeze indicator (❄️) shall be activated.

Quick freeze indicator is illuminated when quick freeze function is activated and fridge compartment temperature indicator is displayed as -27. To cancel this function press quick freeze button (❄️) again.

Quick freeze indicator will turn off and refrigerator will return to its normal settings. Quick freeze function is canceled automatically in 24 hour if you do not cancel it before. If you want to freeze large amounts of fresh food, press the quick freeze button before putting the food into the freezer compartment.

Indicator Panel

Indicator panels may vary depending on your product's model.

Indicator panel aids in using your refrigerator with its audio and visual functions.

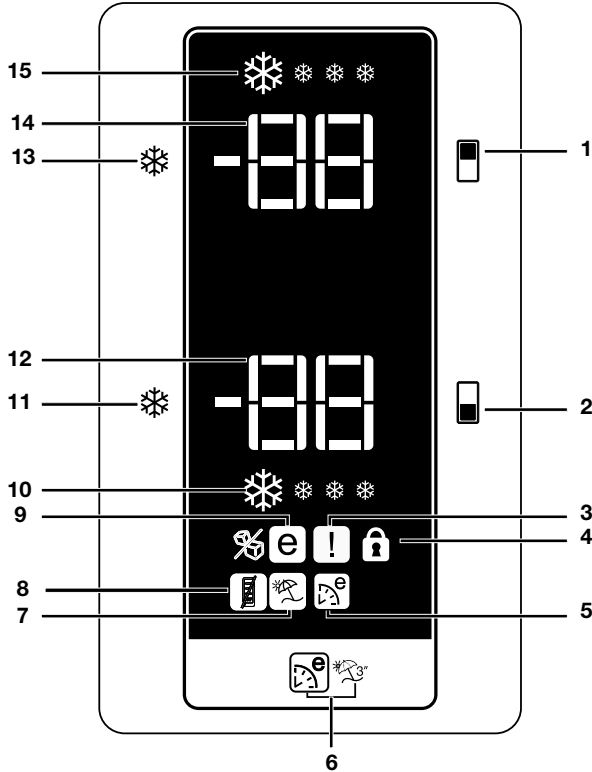

*** OPTIONAL**

- | | |
|---|--|
| <ul style="list-style-type: none"> 1. Fridge compartment setting button 2. Freezer compartment setting/ Icematic on-off button 3. Error status indicator 4. Key lock indicator 5. Eco Extra Function indicator 7. Vacation function indicator 8. Energy saving function (display off) | <ul style="list-style-type: none"> 6. Eco Extra/Vacation Button 9. Economic usage indicator 10. Quick fridge function indicator 11. Quick fridge function button 12. Fridge compartment temperature setting indicator 13. Quick freeze function button 14. Freezer compartment temperature setting indicator 15. Quick freeze function indicator |
|---|--|

ⓘ Figures that take place in this instruction manual are schematic and may not correspond exactly with your product. If the subject parts are not included in the product you have purchased, then it is valid for other models.

1. Fridge Compartment Setting Button

This function allows you to make the fridge compartment temperature setting. Press this button to set the temperature of the fridge compartment to 8, 7, 6, 5, 4, 3, 2, 1 respectively.

2. Freezer Compartment Setting / Icematic On-Off Button

This function allows you to make the freezer compartment temperature setting. Press this button to set the temperature of the freezer compartment to -18, -19, -20, -21, -22, -23 and -24 respectively.

To stop ice formation, press Icematic on-off button for 3 seconds. Water flow from water tank will stop when this function is selected. However, ice made previously can be taken from the Icematic. To restart ice formation, press Icematic on-off button for 3 seconds.

3. Error Status Indicator

If your refrigerator does not cool adequately or if there is a sensor failure, this indicator will be activated. When this indicator is active, Freezer Compartment Temperature indicator will display "E" and Fridge Compartment Temperature Indicator will display numbers such as "1,2,3...". These numbers on the indicator provides information about the error to the service personnel.

When you place hot food into the freezer compartment or if you leave the door open for a long time, exclamation mark can illuminate for some time. This is not a failure; this warning will disappear when the food cools down.

4. Key Lock Indicator

Use this function if you do not want your refrigerator temperature setting changed. Press Fridge compartment setting button and Freezer compartment setting button simultaneously for a long time (3 sec) to activate this function.

5. Eco Extra Function Indicator

It indicates that the Eco-Extra function is active.

If this function is active, your refrigerator will automatically detect the least usage periods and energy-efficient cooling will be performed during those times. Economy indicator will be active while energy-efficient cooling is performed. Press the relevant button again to deactivate this function.

6. Eco Extra/Vacation Button

Press this button briefly to activate the Eco Extra function. Press and hold this button for 3 sec. to activate the Vacation function. Press this button again to deactivate the selected function.

7. Vacation Function Indicator

Indicates that the vacation function is active. If this function is active, "- -" appears on the indicator of the fridge compartment and no cooling is performed in the fridge compartment. Other compartments will be cooled in accordance with the temperature set for them.

Press the relevant button again to deactivate this function.

8. Energy saving function (display off)

If the product doors are kept closed for a long time energy saving function is automatically activated and energy saving symbol is illuminated. When energy saving function is activated, all symbols on the display other than energy saving symbol will turn off. When the Energy Saving function is activated, if any button is pressed or the door is opened, energy saving function will be canceled and the symbols on display will return to normal. Energy saving function is activated during delivery from factory and cannot be canceled.

9. Economy Mode Indicator

Indicates that the refrigerator is running in energy-efficient mode. Freezer Compartment temperature

This indicator will be active if the function is set to -18 or the energy efficient cooling is being performed due to Eco-Extra function.

10. Quick Fridge Indicator

This icon flashes in an animated style when the Quick Fridge function is active.

11. Quick Fridge Function

When you press the Quick Fridge button, the temperature of the compartment will be colder than the adjusted values.

This function can be used for food placed in the fridge compartment and required to be cooled down rapidly.

If you want to cool large amounts of fresh food, it is recommended to activate this feature before putting the food into the fridge.

Quick Fridge indicator turns on when the Quick Fridge function is on. To cancel this function press Quick Fridge button again.

If you do not cancel it, Quick Fridge will cancel itself automatically after 4 hours or when the fridge compartment reaches to the required temperature.

This function is not recalled when power restores after a power failure.

12. Fridge Compartment Temperature Setting Indicator

Indicates the temperature set for the Fridge Compartment.

13. Freezer Compartment Temperature Setting Indicator

Indicates the temperature set for the Freezer Compartment.

14. Quick Freeze Function

Quick Freeze indicator turns on when the Quick Freeze function is active. To cancel this function press Quick Freeze button again. Quick Freeze indicator will turn off and return to its normal settings. If you do not cancel it, Quick Freeze will cancel itself automatically after 8 hours or when the freezer compartment reaches to the required temperature.

If you want to freeze large amounts of fresh food, press the Quick Freeze button before putting the food into the freezer compartment.

If you press the Quick Freeze button repeatedly with short intervals, the electronic circuit protection will be activated and the compressor will not start up immediately.

This function is not recalled when power restores after a power failure.

15. Quick Freeze Indicator

This icon flashes in an animated style when the Quick Freeze function is active.

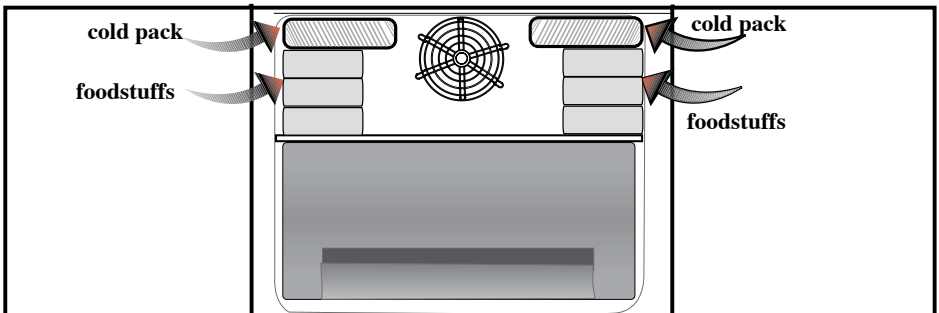

Door Open Warning

***May not be available in all models**

An audio warning signal will be given when the door of your product is left open for at least 1 minute. This warning will be muted when the door is closed or any of the display buttons (if any) are pressed.

Dual cooling system:

Your refrigerator is equipped with two separate cooling systems to cool the fresh food compartment and freezer compartment. Thus, air in the fresh food compartment and freezer compartment do not get mixed. Thanks to these two separate cooling systems, cooling speed is much higher than other refrigerators. Odors in the compartments do not get mixed. Also additional power saving is provided since the defrosting is performed individually.

Freezing fresh food

- Wrap or cover the food before placing them in .
- Hot food must cool down to the room temperature before putting them in the refrigerator.
- The foodstuff that you want to freeze must be fresh and in good quality.
- Foodstuff must be divided into portions according to the family's daily or meal based consumption needs.
- Foodstuff must be packaged in an airtight manner to prevent them from drying even if they are going to be kept for a short time.

- Materials to be used for packagings must be resistant to cold and humidity and they must be airtight. The packaging material of the food must be at a sufficient thickness and durability. Otherwise the food hardened due to freezing may puncture the packaging. It is important for the packaging to be closed securely for safe storage of the food.

- Frozen food must be used immediately after they are thawed and they should never be re-frozen.

- Please observe the following instructions to obtain the best results.

1. If the fridge has a quick freeze function, activate the quick freeze function when you want to freeze the food.
2. Do not freeze too large quantities of food at one time. The quality of the food is best preserved when it is frozen right through to the core as quickly as possible.
3. Take special care not to mix already frozen food and fresh food.
4. Make sure raw foods are not in contact with cooked foods in the fridge.

Freezer Compartment Setting	Fridge Compartment Setting	Remarks
-18°C	4°C	This is the normal recommended setting.
-20, -22 or -24°C	4°C	These settings are recommended when the ambient temperature exceeds 30°C.
Quick Freeze	4°C	Use when you wish to freeze your food in a short time. It is recommended to be used to maintain the quality of meat and fish products.
-18°C or colder	2°C	If you think that your fridge compartment is not cold enough because of the hot conditions or frequent opening and closing of the door.
-18°C or colder	Quick Fridge	You can use it when your fridge compartment is overloaded or if you wish to cool down your food rapidly. It is recommended that you activate the quick freeze function 4-8 hours before placing the food.

Recommendations for preservation of frozen food

- Pre-packed commercially frozen food should be stored in accordance with the frozen food manufacturer's instructions in a frozen food storage compartment.
- To ensure that the high quality supplied by the frozen food manufacturer and the food retailer is maintained, following points should be noted:
 1. Put packages in the freezer as quickly as possible after purchase.
 2. Ensure that contents of the package are labeled and dated.
 3. Do not exceed "Use By", "Best Before" dates on the packaging.

Defrosting

The freezer compartment defrosts automatically.

Placing the food

Freezer compartment shelves	Various frozen food such as meat, fish, ice cream, vegetables and etc.
Egg section	Egg
Fridge compartment shelves	Food in pans, covered plates and closed containers
Door shelves of fridge compartment	Small and packaged food and drinks (such as milk, fruit juice and beer)
Crisper	Vegetables and fruits
Freshzone compartment	Delicatessen products (cheese, butter, salami and etc.)

Deep-freeze information

Food must be frozen as rapidly as possible when they are put in the freezer in order to keep them in good quality.

It is possible to preserve the food for a long time only at -18°C or lower temperatures.

You can keep the freshness of food for many months (at -18°C or lower temperatures in the deep freeze).

WARNING!

- Foodstuff must be divided into portions according to the family's daily or meal based consumption needs.

- Foodstuff must be packaged in an airtight manner to prevent them from drying even if they are going to be kept for a short time.

Materials necessary for packaging:

- Cold resistant adhesive tape
- Self-adhesive label
- Rubber rings
- Pen

Materials to be used for packaging the foodstuff must be tear-proof and resistant to cold, humidity, dour, oils and acids.

Foodstuff to be frozen should not be allowed to come in contact with the previously frozen items to prevent their partial thawing. Thawed out food must be consumed and must not be frozen again.

Odour filter

* OPTIONAL

Odour filter in the air duct of the fridge compartment prevents the build-up of unpleasant odours in the refrigerator.

Egg section

You can place the egg section in any of the door shelves. If it is going to be placed in the body, the lower shelves are recommended due them being cooler.

Never store eggs in the freezer compartment.

Avoid direct contact between eggs and other foods.

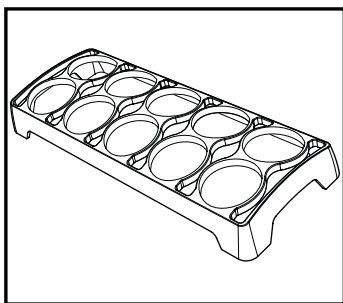

Snack compartments

Use these compartments for your food which you want to store at a temperature a few degrees below the fridge compartment.



You can place the food that you want to freeze in these compartments first in order to prepare them for freezing.

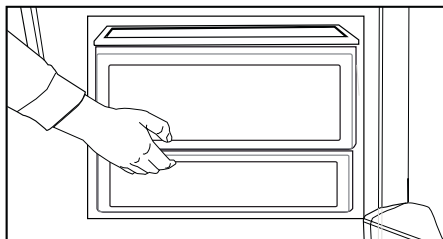

Blue light/VitaminZone

***May not be available in all models**

For the blue light,

Fruits and vegetables stored in the crispers that are illuminated with a blue light continue their photosynthesis by means of the wavelength effect of blue light and thus preserve their vitamin content.

For VitaminZone,

Fruits and vegetables stored in crispers illuminated with the VitaminZone technology preserve their vitamins for a longer time thanks to the blue, green, red lights and dark cycles, which simulate a day cycle.

If you open the door of the refrigerator during the dark period of the VitaminZone technology, the refrigerator will automatically detect this and enable the blue-green or red light to illuminate the crisper for your convenience. After you have closed the door of the refrigerator, the dark period will continue, representing the night time in a day cycle.

Water Dispenser

(in some models)

Water dispenser is a very useful feature based on reaching cold water without opening the door of your refrigerator. As you will not have to open your refrigerator door frequently, you will have saved energy.

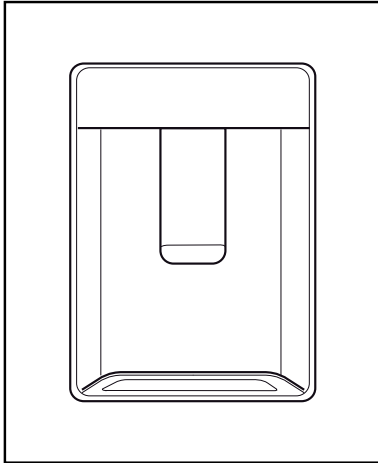

Using the water spring

Push the arm of the water dispenser with your glass. The dispenser will cease operating once you release the arm.

When operating the water dispenser, maximum flow can be obtained by pressing the arm fully. Please remember that the amount of flow from the dispenser is subject to the degree you press the arm.

As the level of the water in your glass/ container rises, slightly lessen the pressure on the arm to prevent the overspill. If you slightly press the arm, the water will drop; this is quite normal and not a failure.

Filling the water dispenser water tank

Water tank filling reservoir is located inside the door rack. Open the reservoir cover and fill in clean potable water. And then, close the lid.

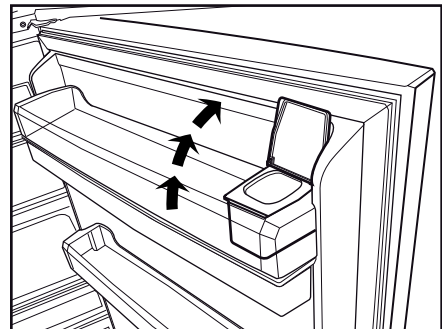
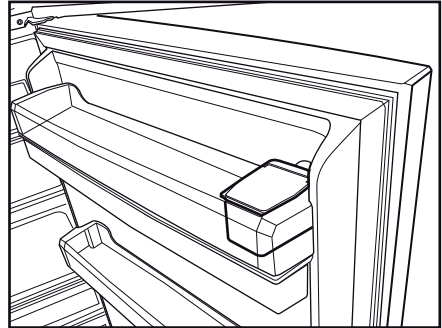

Warning!

- Do not fill the water tank with any other liquid except for water such as fruit juices, carbonated beverages or alcoholic drinks which are not suitable to use in the water dispenser. Water dispenser will be irreparably damaged if these kinds of liquids are used. Warranty does not cover such usages. Some chemical substances and additives contained in these kinds of drinks/liquids may damage the water tank material.

- Use clean and pure potable water only.
- Capacity of the water tank is 3 liters; do not overfill.
- Push the arm of the water dispenser with a rigid glass. If you are using disposable plastic glasses, push the arm with your fingers from behind the glass.

Cleaning the water tank

- Remove the water filling reservoir inside the door rack.
- Remove the door rack by holding from both sides.
- Grab the water tank from both sides and remove it with an angle of 45°.
- Clean the water tank by removing its lid.

Important:

Components of the water tank and water dispenser should not be washed in dishwasher.

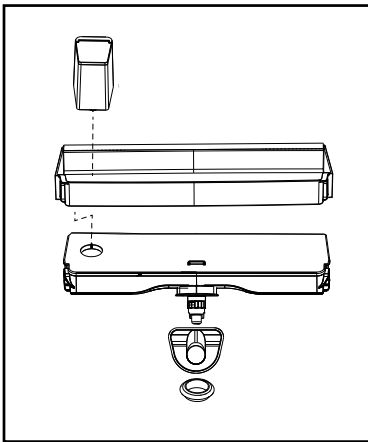
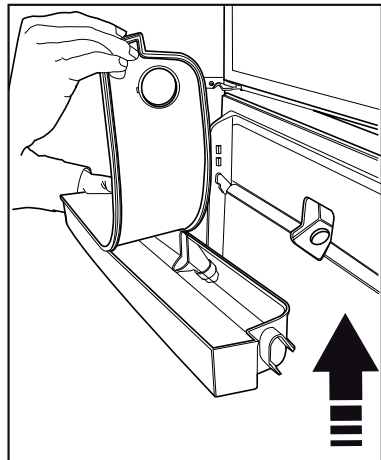
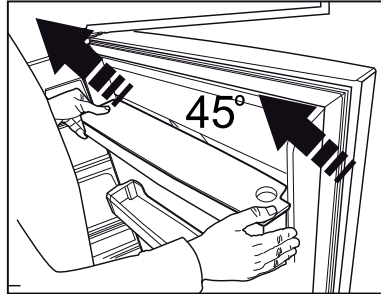
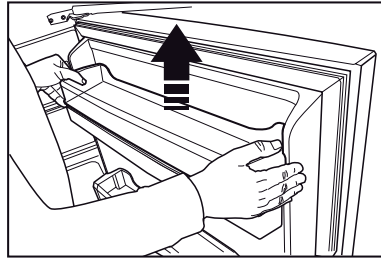
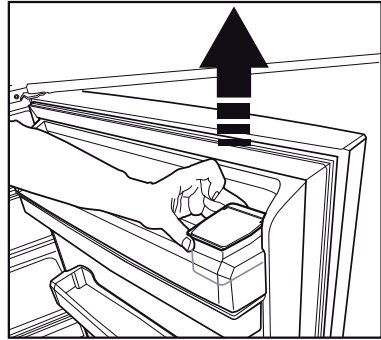

Water tray

Water that dripped while using the water dispenser accumulates in the spillage tray.

Take out the plastic strainer as shown in the figure.

With a clean and dry cloth, remove the water that has accumulated

CAUTION: Connect only to a potable water line.

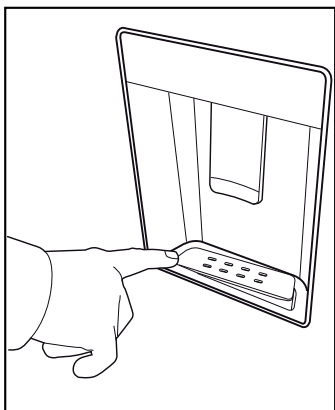

Sliding storage container

*optional

This accessory is designed to increase the usage volume of the door shelves. It allows you to easily place the tall bottles, jars and tins to the lower bottle shelf thanks to its ability to move right or left.

[The illustrated figure is only an example and does not match exactly with your product.]

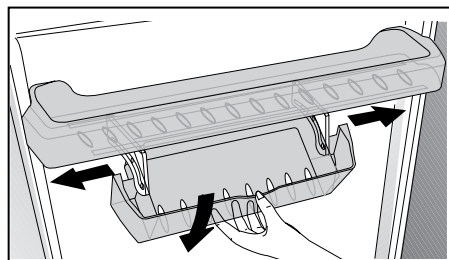

Rotary storage container

[in some models]

Sliding body shelf can be moved to left or right in order to allow you place the tall bottles, jars or boxes to the lower shelf (Fig. 1)

You can reach the food that you have placed into the shelf by grabbing and turning it from its right edge (Fig.2).

When you want to load or remove it to clean, turn it by 90 degrees, raise it up and pull towards yourself (Fig. 3-4).

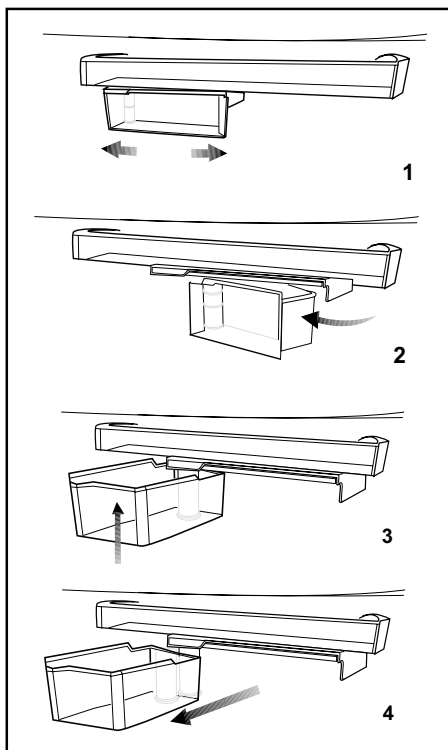

Ice making

Fill iceboxes with water and place them as seen in the picture into the ice shelf at the ceiling which is partially opened when the top drawer of the freezer is pulled out.

Your ice will be ready in approximately two hours. You can take out the ice cubes in the ice container by removing it from the freezer and slightly twisting it.

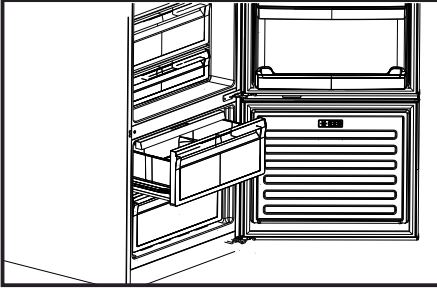

Movable Body shelf:

*optional

Manually movable body shelf is an option enabling the usage of interior shelf volume of the refrigerator in a flexible way.

When you want to store an item which is taller than the distance between two shelves, slide the manually movable body shelf holding it from its grips as shown in the figure and this will enable you to move the shelf upwards. By sliding the grip to the right, you can move the manual body shelf only 45 mm upwards.

The manually movable body shelf can only be moved with max 10 kg load on it.

If more than 10 kg will be loaded, then it should be used as a fixed shelf like others. In this case, if it is required to adjust the shelf height, first empty the food stuff,

adjust it as per your height requirement and then load it with the food stuff. The shelf is intended to carry max. 40 kg while used as a fixed shelf.

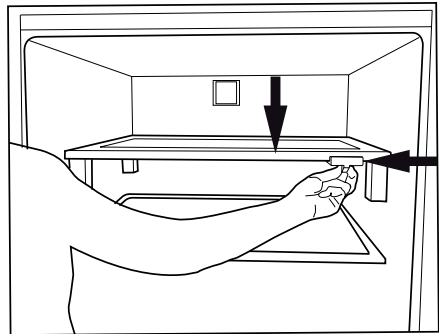
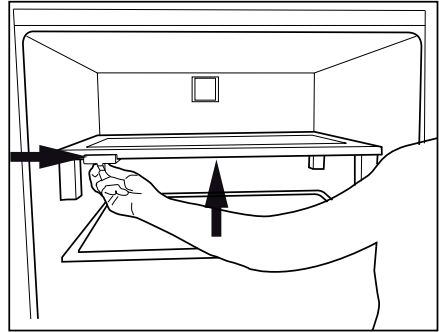

Humidity Controlled Crisper

(FreShelf)

*optional

Humidity controlled crisper feature keeps the humidity of vegetables and fruits under control and allows keeping the food fresh for a much longer time.

We recommend you to place vegetables with leaves such as lettuce, spinach and vegetables vulnerable to humidity loss not vertical on their roots but horizontal in the crispers.

While placing the vegetables consider their weight and place the heavy and solid vegetable to the bottom, light and soft vegetables to the top.

Do not leave vegetables within plastic bags in the crispers. Leaving vegetables in plastic bags will make them spoil in a very short time. If it is required to separate vegetables for hygienic purposes, then use porous paper packing materials instead of plastic bags.

Do not place fruits, mainly apple and also pear, apricot, peach etc. which produce ethylene gas together with other vegetables-fruits in the same crisper. The ethylene produced by these fruits will cause other vegetables-fruits to mature rapidly and then cause them to spoil in a shorter time.

HerbBox/HerbFresh

Remove the film container from HerbBox/HerbFresh+

Take the film out of the bag and put it into the film container as shown in the image. Seal the container again and replace it into HerbBox/HerbFresh+ unit.

HerbBox-HerbFresh+ sections are especially ideal for storage of various herbs that are supposed to be kept in delicate conditions. You can store your unbagged herbs (parsley, dill, etc.) in this section horizontally and keep them fresh for a much longer period.

The film shall be replaced in every six months.

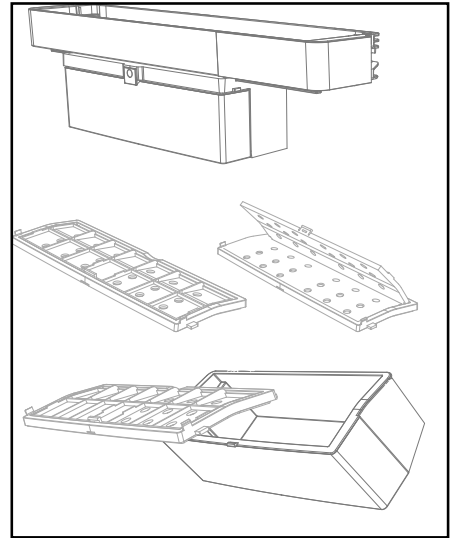



6 Maintenance and cleaning

 Never use gasoline, benzene or similar substances for cleaning purposes.

 We recommend that you unplug the appliance before cleaning.

 Never use any sharp abrasive instrument, soap, household cleaner, detergent and wax polish for cleaning.

 For non-No Frost products, water drops and frosting up to a fingerbreadth occur on the rear wall of the Fridge compartment. Do not clean it; never apply oil or similar agents on it.

 Only use slightly damp microfiber cloths to clean the outer surface of the product. Sponges and other types of cleaning cloths may scratch the surface.

 Use lukewarm water to clean the cabinet of your refrigerator and wipe it dry.

 Use a damp cloth wrung out in a solution of one teaspoon of bicarbonate of soda to one pint of water to clean the interior and wipe it dry.

 Make sure that no water enters the lamp housing and other electrical items.

 If your refrigerator is not going to be used for a long period of time, unplug the power cable, remove all food, clean it and leave the door ajar.

 Check door seals regularly to ensure they are clean and free from food particles.

 To remove door racks, remove all the contents and then simply push the door rack upwards from the base.

 Never use cleaning agents or water that contain chlorine to clean the outer surfaces and chromium coated parts of the product. Chlorine causes corrosion on such metal surfaces.

 Do not use sharp, abrasive tools, soap, household cleaning agents, detergents, kerosene, fuel oil, varnish etc. to prevent removal and deformation of the prints on the plastic part. Use lukewarm water and a soft cloth for cleaning and then wipe it dry.

Protection of plastic surfaces

 Do not put the liquid oils or oil-cooked meals in your refrigerator in unsealed containers as they damage the plastic surfaces of your refrigerator. In case of spilling or smearing oil on the plastic surfaces, clean and rinse the relevant part of the surface at once with warm water.

7 Troubleshooting

Check this list before contacting the service. Doing so will save you time and money. This list includes frequent complaints that are not related to faulty workmanship or materials. Certain features mentioned herein may not apply to your product.

The refrigerator is not working.

- The power plug is not fully settled. >>> Plug it in to settle completely into the socket.
- The fuse connected to the socket powering the product or the main fuse is blown. >>> Check the fuses.

Condensation on the side wall of the cooler compartment (MULTI ZONE, COOL, CONTROL and FLEXI ZONE).

- The door is opened too frequently >>> Take care not to open the product's door too frequently.
- The environment is too humid. >>> Do not install the product in humid environments.
- Foods containing liquids are kept in unsealed holders. >>> Keep the foods containing liquids in sealed holders.
- The product's door is left open. >>> Do not keep the product's door open for long periods.
- The thermostat is set to too low temperature. >>> Set the thermostat to appropriate temperature.

Compressor is not working.

- In case of sudden power failure or pulling the power plug off and putting back on, the gas pressure in the product's cooling system is not balanced, which triggers the compressor thermic safeguard. The product will restart after approximately 6 minutes. If the product does not restart after this period, contact the service.

- Defrosting is active. >>> This is normal for a fully-automatic defrosting product. The defrosting is carried out periodically.
- The product is not plugged in. >>> Make sure the power cord is plugged in.
- The temperature setting is incorrect. >>> Select the appropriate temperature setting.
- The power is out. >>> The product will continue to operate normally once the power is restored.

The refrigerator's operating noise is increasing while in use.

- The product's operating performance may vary depending on the ambient temperature variations. This is normal and not a malfunction.

The refrigerator runs too often or for too long.

- The new product may be larger than the previous one. Larger products will run for longer periods.
- The room temperature may be high. >>> The product will normally run for long periods in higher room temperature.
- The product may have been recently plugged in or a new food item is placed inside. >>> The product will take longer to reach the set temperature when recently plugged in or a new food item is placed inside. This is normal.
- Large quantities of hot food may have been recently placed into the product. >>> Do not place hot food into the product.
- The doors were opened frequently or kept open for long periods. >>> The warm air moving inside will cause the product to run longer. Do not open the doors too frequently.

- The freezer or cooler door may be ajar. >>> Check that the doors are fully closed.
- The product may be set to temperature too low. >>> Set the temperature to a higher degree and wait for the product to reach the adjusted temperature.
- The cooler or freezer door washer may be dirty, worn out, broken or not properly settled. >>> Clean or replace the washer. Damaged / torn door washer will cause the product to run for longer periods to preserve the current temperature.

The freezer temperature is very low, but the cooler temperature is adequate.

- The freezer compartment temperature is set to a very low degree. >>> Set the freezer compartment temperature to a higher degree and check again.

The cooler temperature is very low, but the freezer temperature is adequate.

- The cooler compartment temperature is set to a very low degree. >>> Set the freezer compartment temperature to a higher degree and check again.

The food items kept in cooler compartment drawers are frozen.

- The cooler compartment temperature is set to a very low degree. >>> Set the freezer compartment temperature to a higher degree and check again.

The temperature in the cooler or the freezer is too high.

- The cooler compartment temperature is set to a very high degree. >>> Temperature setting of the cooler compartment has an effect on the temperature in the freezer compartment. Wait until the temperature of relevant parts reach the sufficient level by

changing the temperature of cooler or freezer compartments.

- The doors were opened frequently or kept open for long periods. >>> Do not open the doors too frequently.
- The door may be ajar. >>> Fully close the door.
- The product may have been recently plugged in or a new food item is placed inside. >>> This is normal. The product will take longer to reach the set temperature when recently plugged in or a new food item is placed inside.
- Large quantities of hot food may have been recently placed into the product. >>> Do not place hot food into the product.

Shaking or noise.

- The ground is not level or durable. >>> If the product is shaking when moved slowly, adjust the stands to balance the product. Also make sure the ground is sufficiently durable to bear the product.
- Any items placed on the product may cause noise. >>> Remove any items placed on the product.

The product is making noise of liquid flowing, spraying etc.

- The product's operating principles involve liquid and gas flows. >>> This is normal and not a malfunction.

There is sound of wind blowing coming from the product.

- The product uses a fan for the cooling process. This is normal and not a malfunction.

There is condensation on the product's internal walls.

- Hot or humid weather will increase icing and condensation. This is normal and not a malfunction.
- The doors were opened frequently or kept open for long periods. >>> Do not

open the doors too frequently; if open, close the door.

- The door may be ajar. >>> Fully close the door.

There is condensation on the product's exterior or between the doors.

- The ambient weather may be humid, this is quite normal in humid weather. >>> The condensation will dissipate when the humidity is reduced.

The interior smells bad.

- The product is not cleaned regularly. >>> Clean the interior regularly using sponge, warm water and carbonated water.
- Certain holders and packaging materials may cause odour. >>> Use holders and packaging materials without free of odour.
- The foods were placed in unsealed holders. >>> Keep the foods in sealed holders. Micro-organisms may spread out of unsealed food items and cause malodour. Remove any expired or spoilt foods from the product.

The door is not closing.

- Food packages may be blocking the door. >>> Relocate any items blocking the doors.
- The product is not standing in full upright position on the ground. >>> Adjust the stands to balance the product.
- The ground is not level or durable. >>> Make sure the ground is level and sufficiently durable to bear the product.

The vegetable bin is jammed.

- The food items may be in contact with the upper section of the drawer. >>> Reorganize the food items in the drawer.

If The Surface Of The Product Is Hot.

- High temperatures may be observed between the two doors, on the side panels and at the rear grill while the product is operating. This is normal and does not require service maintenance! Be careful when touching these areas.



WARNING:

If the problem persists after following the instructions in this section, contact your vendor or an Authorised Service. Do not try to repair the product.

DISCLAIMER/WARNING

Some [simple] malfunctions may be repaired by end users without creating any safety issue or causing unsafe usage provided that they are carried out under the following instructions.

(Please see the section "I Want to Repair Myself".)

For this reason, except for parts specified at the section "I Want to Repair Myself" as could be repaired by end users, repair by an authorized service station is definitely suggested for the purpose of preventing any safety issues and this is required so that Arçelik product warranty may continue.

I WANT TO REPAIR MYSELF

Repair that will be carried out by end users can be performed within the following spare parts: Door Handles and Door Hinges, Door Joints and peripheral Trays, Baskets, Racks. (You may have access to current list of spare parts from <https://www.arcelik.com.tr/destek> as of 1 March 2021)

Further, in order to ensure product safety and to prevent risk of severe injuries, repair has to be carried out according to instructions from user manual or <https://www.arcelik.com.tr/destek>. For your own safety, please unplug product prior to carrying out any repair.

Arçelik may not be held responsible for safety issues that may arise because of repairs or attempts not carried out in accordance with instructions specified at user manuals or located at <https://www.arcelik.com.tr/destek> and performed on parts other than parts contained at current list of parts accessed from <https://www.arcelik.com.tr/destek>. In such a case, Arçelik product warranty will be invalid.

For this reason, we strongly recommend end users to avoid carrying out repairs for parts other than above-mentioned spare parts themselves and apply to an authorized service station in case of requirement. Such repair attempts by end users may cause safety issues, may damage product and may cause fire, flood, electrocution and severe personal injuries afterwards.

Including but not limited to the listed items, repairs of the following parts have to be performed by authorized service stations: Compressor, Cooling system elements, Motherboard, Inverter card, Display card, etc.

Manufacturer/dealer may not be held responsible for any circumstances where end users fail to act in accordance with the foregoing.

This product is equipped with a lighting source of the "G" energy class.

The lighting source in this product shall only be replaced by professional repairers.